

Article number: 4320000191

Description: Rota-fix shaft-hub connection A 19x47  
Stainless Steel

## Measures

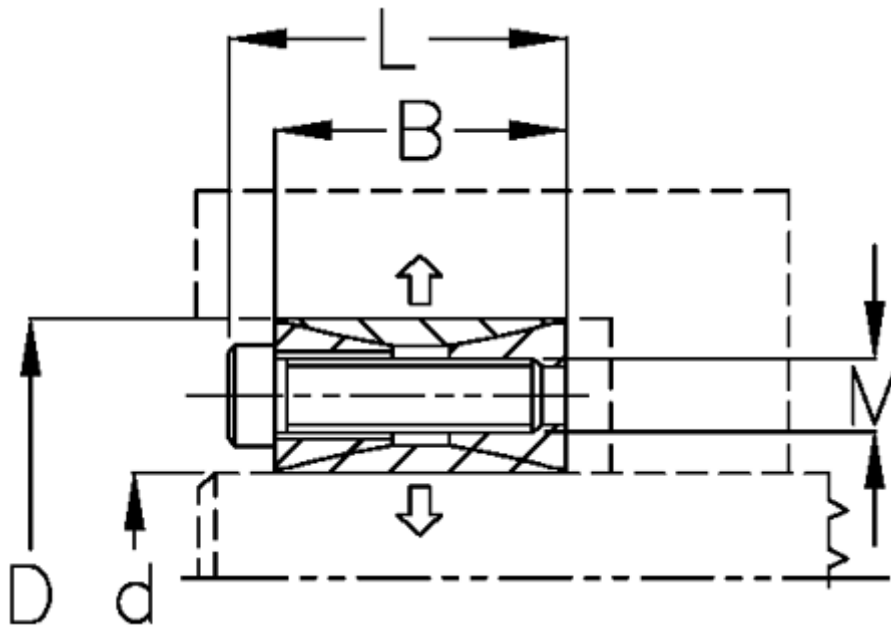

B mm	= 20
d H8 mm	= 19
D mm	= 47
Fit tolerance	= Aksel k11-h11, Nav N11-H11
F kN torque	= 17.0
L mm	= 26
M mm	= M6
P N/mm <sup>2</sup> surface pressure on shaft/hub	= 31

Surface roughness	=
T N m torque	=
Ts N m bolt tightening torque	=